

DeviceNet

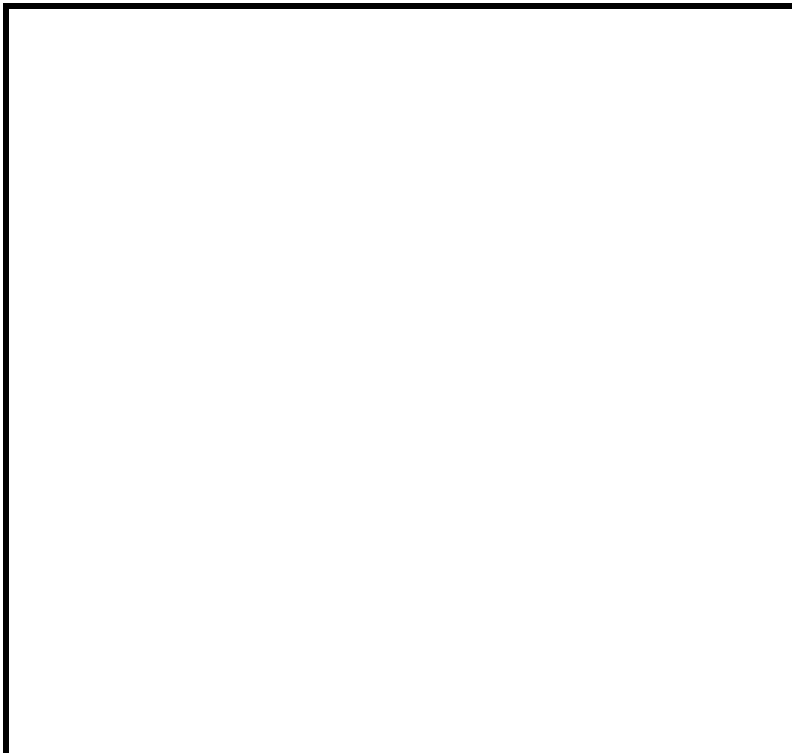





This manual was downloaded on www.sdsdrives.com
+44 (0)117 938 1800 - info@sdsdrives.com



Bus interface DeviceNet for Digital servo controller 635/637/ 637+



Further documentations, related to this document.

UL: 	DeviceNet Specification
UL: 07-01-05-06 	635 - Product-manual
UL: 07-02-08-03 	637 - Product-manual
UL: 07-02-09-01 	637+ - Product-manual
UL: 10-06-05 	BIAS - Command Description
UL: 10-06-03 	Serial transfer protocol EASY-serial - Product Description

© **EUROTHERM** Drives Limited.

All rights reserved. No portion of this description may be produced or processed in any form without the consent of the company.

Changes are subject to change without notice.

EUROTHERM has registered in part trademark protection and legal protection of designs.
The handing over of the descriptions may not be construed as the transfer of any rights.

Made in Germany, 2002



CONTENTS

page

The most important thing first.....	5
1 User manual for the Digital drive 635/637/637+ with the bus system DeviceNet.....	6
1.1 Layout	6
2 Basic features of the DeviceNet bus with 635/637/637+.....	7
2.1 Communication	7
2.2 Vendor ID.....	7
2.3 Nodeaddress, MAC ID.....	7
2.4 Bus termination	7
2.5 Baudrate adjustment.....	8
2.6 Pin assignment for COM2.....	9
2.7 Cables and accessories	9
3 DeviceNet data transfer	10
4 Configuration.....	11
4.1 Short list of instructions for initialization 635/637/637+ for DeviceNet bus connection	11
5 Definitions of the data fields.....	12
5.1 Numbers representation in the serial commands	13
5.1.1 2 byte hexadecimal values (WORD).....	13
5.1.2 4 byte hexadecimal values (LWORD)	13
5.2 Parameter scaling	13
6 Vendor class 100: Receive control block.....	14
6.2 Host login / logout (1/2).....	15
6.3 Control word „start absolute“(3) and „start incremental“(4)	15
6.4 Control word „start search for reference“(5)	16
6.5 Control word „stop“(6)	16
6.6 Control word “stop with braking ramp“(7).....	16
6.7 Control word „preset counter“(8)	17
6.8 Control word „set BIAS processing pointer“(9).....	17
6.9 Control word „move +“(10) and „move -“(11).....	18
6.10 Control word „move synchronous“(12).....	18
6.11 Control word „synchron setting“(13).....	19
6.12 Control word „load ramp“(19)	19
6.13 Control words 635/637/637+: „disable/enable“(20/21)	19
6.14 Control word 635/637/637+: „RESET“(22)	20
6.15 Control words 635/637/637+: „save data“(23)	20
6.16 Control word „operating mode speed loop“(24).....	21
6.17 Control word „write variable / flags“(25).....	21



CONTENTS

page

7	Vendor class 100	22
7.1	Vendor class 100: Attr. 100 „read status”	22
7.2	Vendor class 100: Attr. 101 „ext. read status”	23
8	Vendor class 101: Attr. 0 - 255 „read variable“	24
9	Reserved	24
10	Example for operating the 635/637637+ via the DeviceNet bus system	25
10.1	Positioning via DeviceNet.....	25
10.2	BIAS programm-selection via DeviceNet	29
11	Eurotherm servo controller communicate with the Allen-Bradley plc	31
11.1	Network Configuration with RSNetWorx	31
11.2	PLC programing with RSLogix 500 (Allen-Bradley).....	32
11.2.1	Transmitting data between the processor files and the M0- / M1-files	33
11.2.2	Programming control for Explicit Messaging Service.....	34
12	Reserved	34
13	Standard reference (Homing) modes overview	35
13.1	Search for reference and modes	35
13.2	Search for reference to the resolver zero position.....	36
13.3	Search for reference to the reference sensor	37
13.4	Search for reference to the reference sensor <u>and</u> the resolver zero position.....	38
13.5	Search for reference with automatic directional selection	38
13.6	Search for reference with reference point shifting.....	39
14	Index	40
15	Modification Record	42



The most important thing first

We thank you for the trust that you have shown in our product.

The operating instructions presented themselves as an overview of the technical data and features.

Please read the operating instructions before putting the product to use.

If you have any questions, please contact your nearest Eurotherm representative.

Improper application of the product in connection with dangerous voltage, can lead to injuries.

In addition, damage can also occur to motors or other products.

Therefore please observe our safety precautions strictly.

Topic: Safety precautions

We assume that, as an expert, you are familiar with the relevant safety regulations, especially in accordance with VDE 0100, VDE 0113, VDE 0160, EN 50178, the accident prevention regulations of the employers liability insurance company and the DIN regulations and that you can use and apply them. Also the CE - regulations are to be observed and guaranteed.

Depending on the kind of application, additional norms e.g. UL, DIN are to be observed.

If our products are employed in connection with components from other manufacturers, their operating instructions are also to be observed strictly.



1 User manual for the Digital drive 635/637/637+ with the bus system DeviceNet

A DeviceNet bus interface (RP_DEV) can be integrated as an option into the 635 and 637/637+ digital servo controller. Consequently it is possible to network the 635/637/637+ as participant in the DeviceNet bus system..

The functions described in this documentation refer to following software version:

Controller firmware: Version \geq 6.16

DeviceNet-firmware: Version 2.01

1.1 Layout

a) 635 - top view

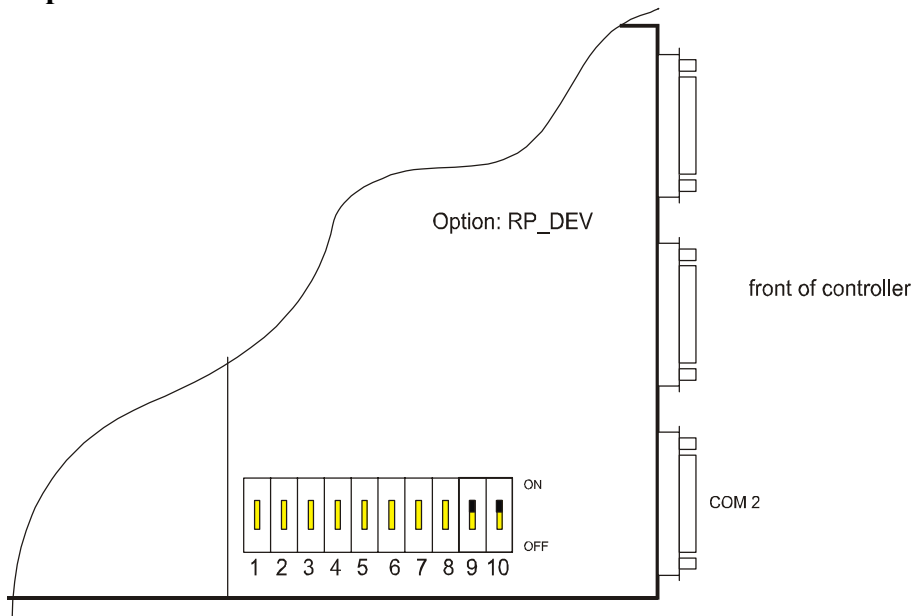

b) 637/637+ - top view

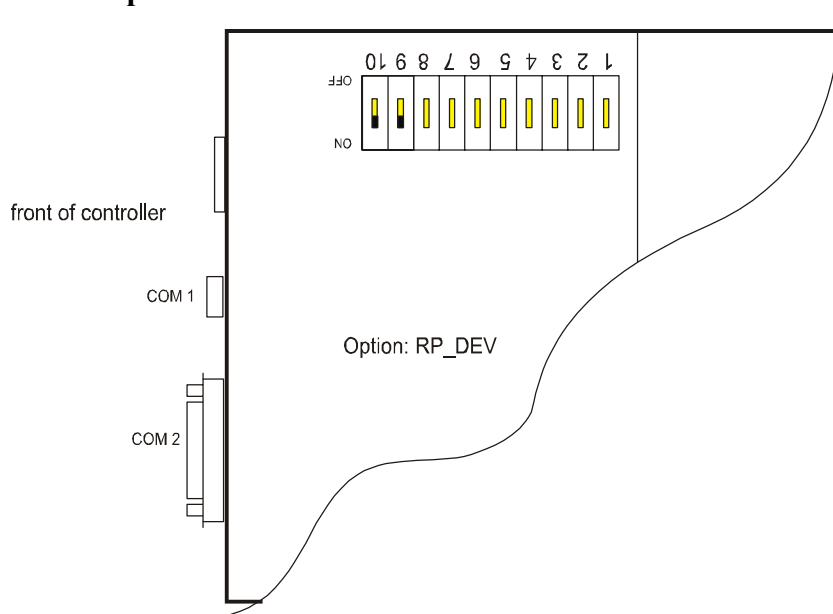



2 Basic features of the DeviceNet bus with 635/637/637+

2.1 Communication

A **shielded twisted pair cable** is to be used as the bus cable.
(for pin assignment see chapter 2.2)

The DeviceNet interface is galvanically isolated. A CAN-transceiver on the 635/637/637+ can be used for coupling onto the bus in accordance with **ISO/DIS 11898**.

The maximum cable length depends on the selected transmission rate:

125 kBit/s: approx. **500 m** cable length

250 kBit/s: approx. **300 m** cable length

500 kBit/s: approx. **100 m** cable length

The Digital drive 635/637/637+ supports all data rates listed above.

2.2 Vendor ID

All vendors that produce DeviceNet nodes will be assigned an unique Vendor Identification Code (Vendor ID) by the ODVA.

The ODVA (**O**pen **D**eviceNet **V**endor **A**ssociation) is an independent supplier organisation which manages the DeviceNet Specification and supports the world-wide growth of DeviceNet.

DeviceNet Vendor ID: 609

2.3 Nodeaddress, MAC ID¹

The nodeaddress 0-63 (MAC ID) is selected with the DIL switches 1-6.

(DIL 1 = 2^5 , DIL 6 = 2^0 !!)

Note: The nodeaddress may only once be assigned in the DeviceNet bus.

2.4 Bus termination

A defined quiescence level on the bus must be guaranteed for communication. It is necessary to use terminal resistors on both ends of the line.

Is the drive the end of the line is possible to switch on the terminal resistor with DIL switch 10 0 "on".

¹ Media Access Control Identifier



Basic features of the DeviceNet bus with 635/637/637+

2.5 Baudrate adjustment

The baudrate is selected with the DIL switches 7 and 8.

7	8	
0	0	= 125 kBaud
0	1	= 250 kBaud
1	0	= 500 kBaud
1	1	= 125 kBaud

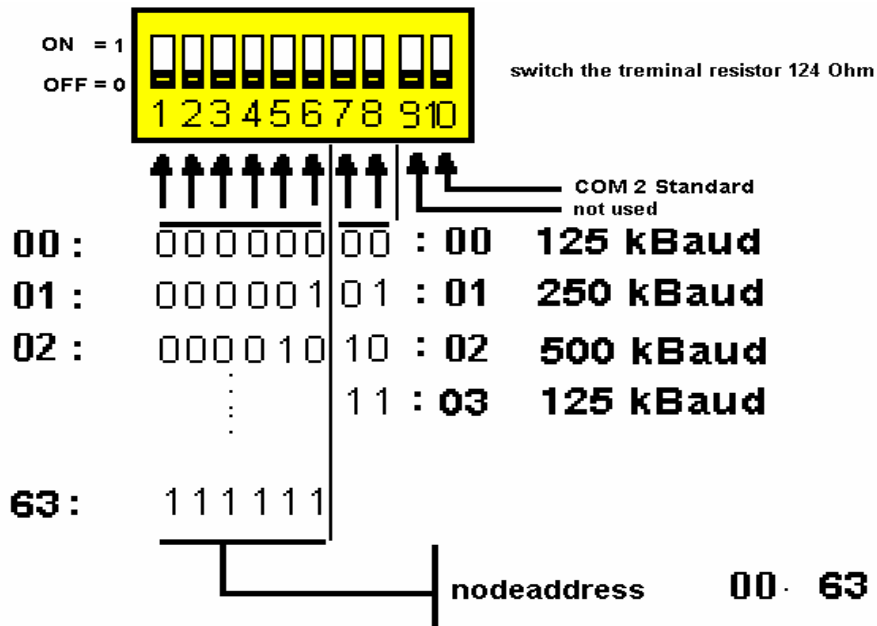



Basic features of the DeviceNet bus with 635/637/637+

2.6 Pin assignment for COM2

Connection plug: **SUB D 9-pin-male**

The CAN interface is galvanically isolated which makes the physical transmission free of interference.

Provided module: **RP_DEV**

Pin	Description	Designation
1		
2	CAN_L bus line (dominant low)	CAN_L
3	Ground	GND
4		
5		
6	optional ground	(GND)
7	CAN_H bus line (dominant high)	CAN_H
8		
9	intern not connected; optional CAN external positive supply.	(CAN_V+)

2.7 Cables and accessories



3 DeviceNet data transfer

In the DeviceNet bus the controller works as a "slave server of class 2".

The initialization and bus configuration is defined in the "Pre-defined master slave CONNECTION Set".

Data exchange between master and slave works with „Explicit message“.

Supplementary the controller adds to the objects necessary for connection setup (services), the services

Get_Attribut_Single 0x0E; read attribut

Set_Attribut_Single 0x10; write attribut

With the the vendor-specific objects

class id 100, instance 1 attribut 100, 101

and

class id 101, instance 1, attribute 0 – 255.

is hereby data exchange possible to and from the controller.

The contents of the services are described in chapters 5, 6 and 7 more closely.

function	service	class	instance	attribut	data
send controlword	Set_Attribut_Single 0x10	100	1	100	8 byte
read status	Get_Attribut_Single 0x0E	100	1	100	8 byte
read ext.status	Get_Attribut_Single 0x0E	100	1	101	8 byte
read variablen	Get_Attribut_Single 0x0E	101	1	0 –255	4 byte



4 Configuration

4.1 Short list of instructions for initialization 635/637/637+ for DeviceNet bus connection

- Selection of the baudrate and nodeaddress with the DIL switches.(see chapter 1 and 2)
If the drive is the end of the line switch the bus termination resistor on. (see chapter 2.4)

Note: The nodeaddress may be only once available in the net.
The baudrate must be identical at all devices in the net.

- Connect the Digital drive 635/637/637+ with the bus cable to the master.
- Switch on the controlvoltage of the drive
- Initializing the DeviceNet bus connection on the 635/637/637+ is done automatically with the plug and play code
- After controlvoltage on the drive automatically sends the message:
"Duplicate MAC ID check"
- Now communication is possible with the 635/637/637+ via the DeviceNet bus by using the defined messages..
- With the menu item „diagnosis/field bus diagnosis“, the communication state of the DeviceNet-Bus of the drive can be diagnosed in EASYRIDER software.



5 Definitions of the data fields

With DeviceNet for 635/637/637+ drives, a telegram can contain up to 8 bytes of useful data,

With the 635/637/637+ the the vendor-specific object **class id 100, instance 1 attribut 100,101** is a telegram always assembled from **8 bytes** of useful data.

The control telegrams consist of a control Word and the subsequent parameter.

The first two bytes form the control word defines the meaning of the telegram. In the remaining useful data (bytes 2 to 7) are the parameters corresponding to the selected control word.

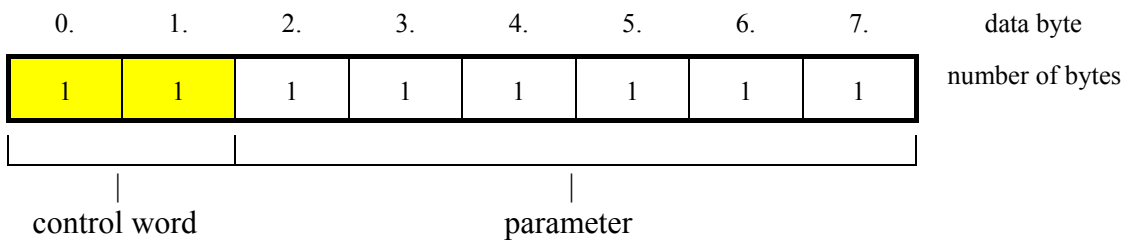



Definitions of the data fields

5.1 Numbers representation in the serial commands

5.1.1 2 byte hexadecimal values (WORD)

Number range $\pm 2^{15}$ (signed integer)

Example: The hexadecimal value 0123h represents itself as follows:

01 = High-Byte (Byte 1)

23 = Low-Byte (Byte 2)

Precedence within the serial command:

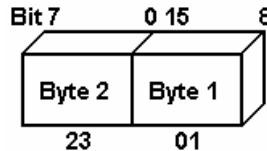

5.1.2 4 byte hexadecimal values (LWORD)

Zahlenbereich $\pm 2^{31}$ (signed long) A negative speed is created through the 2 complement.

Example: The hexadecimal value 01234567h represents itself as follows:

01 = High-Byte (Byte 1)

23 = Low-Byte (Byte 2)

45 = High-Byte (Byte 3)

67 = Low-Byte (Byte 4)

Precedence within the serial command:

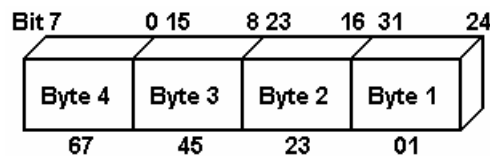

5.2 Parameter scaling

number	scaling
speed	value = v [rpm]
acceleration, deceleration:	value = a [rpm/s] 5



6 Vendor class 100: Receive control block

DeviceNet DATA CHANNEL

(participant → Digital drive 635/637/637+)

6.1 Contents of the control word byte 0

command-number		command description			notes
dec	hex				
0	00	read status			
1	01	Host login			attention! 2. interface login
2	02	Host logout	yes		
3	03	start absolute position	yes	yes	
4	04	start incremental position	yes	yes	
5	05	start reference run	yes	yes	reference mode see chapter 9
6	06	stop		yes	
7	07	stop (with braking ramp)		yes	
8	08	preset counter	yes	yes	
9	09	set BIAS-processing pointer	yes	yes	only in operating-mode 5 with BIAS
10	0A	move +	yes	yes	
11	0B	move -	yes	yes	
12	0C	move synchron	yes	yes	
13	0D	synchron adjustment	yes	yes	
14	0E	not used			
15	0F	not used			
16	10	not used			
17	11	not used			
18	12	not used			
19	13	load ramps	yes		
20	14	deactivate Digital drive		yes	
21	15	activate Digital drive		no	
22	16	reset Digital drive	yes	no	
23	17	store data in drive	yes	no	
24	18	operating mode speed (serial)	yes		
25	19	write variable/ flag			



Vendor class 100: Receive control block

6.2 Host login / logout (1/2)

The most applications telegrams to the digital drive only accept after HOST login. The HOST login is only necessary once a time after power on.

For host login / logout only the control word of the 635/637/637+ is used. The contents of the data bytes 2 - 7 should be 0. They are not analyzed.

Note !!: Only one interface will be have a login (COM 1 or COM 2).

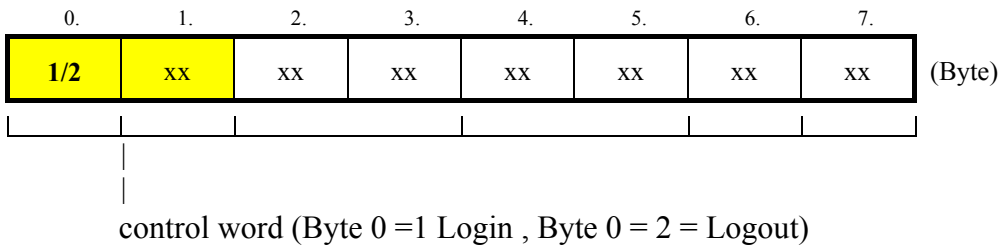

6.3 Control word „start absolute“(3) and „start incremental“(4)

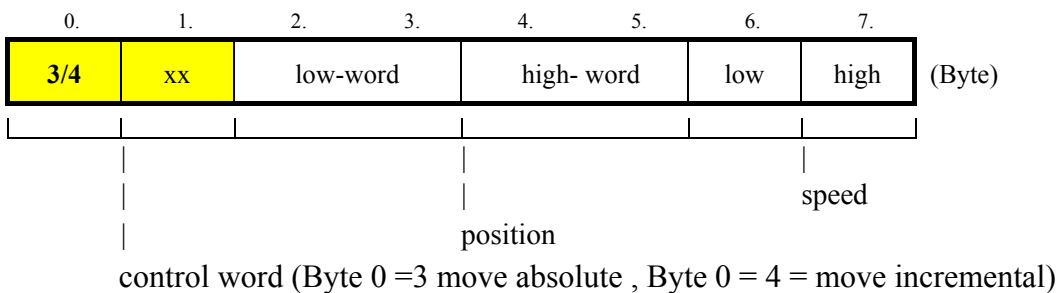

In the operating mode position control only positive speed values are permitted. A negative position is created through their 2 complement.

Example:

$$+ 100.000 \equiv 0x000186A0$$

$$- 100.000 \equiv 0xFFFE795F$$



Vendor class 100: Receive control block

6.4 Control word „start search for reference“(5)

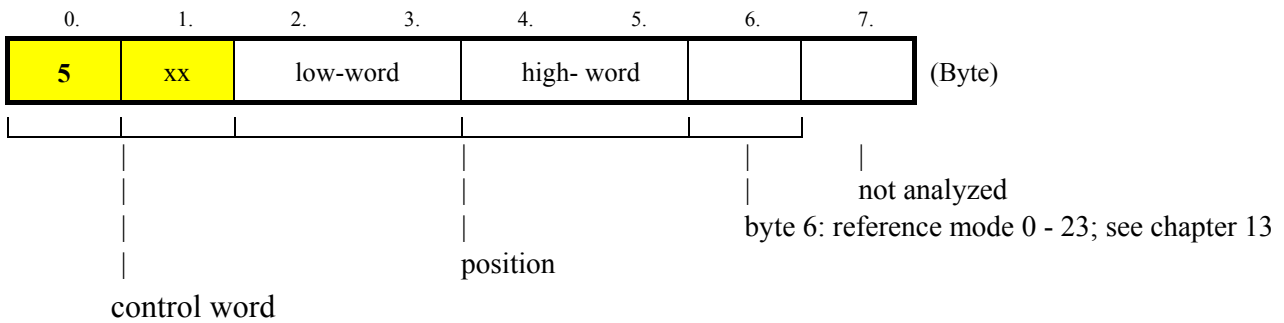

The search for reference is only started, if the Bit “position reached“ is set (= 1).
(See also chapter: -Data contents of the status buffers-)

The speed for the search for reference can be changed with the telegram ,
move incremental (position = 0 !!)

6.5 Control word „stop“(6)

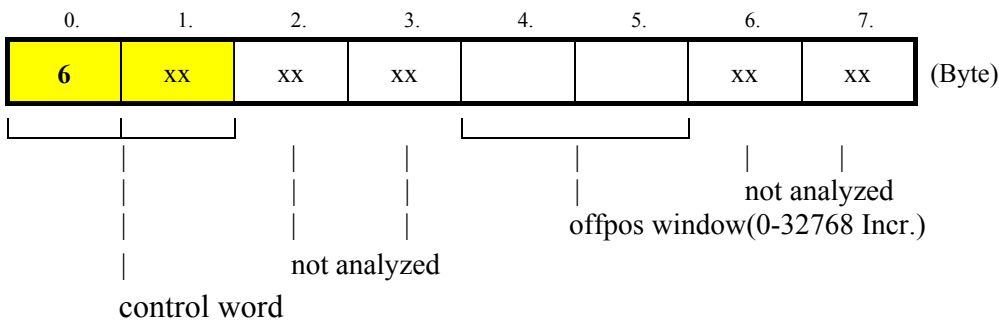

6.6 Control word “stop with braking ramp“(7)

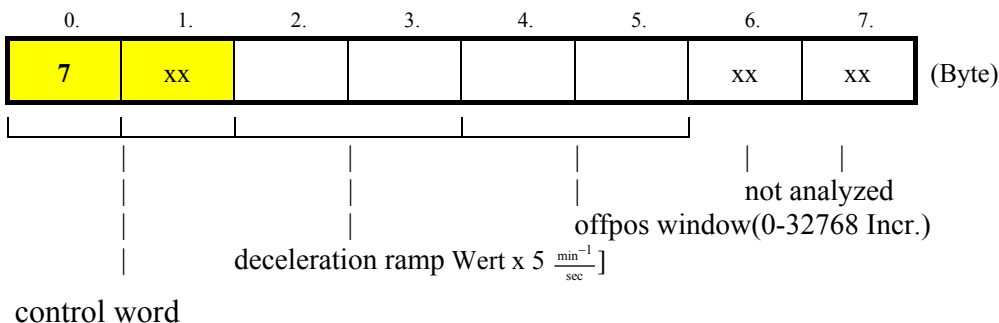



Vendor class 100: Receive control block

6.7 Control word „preset counter“(8)

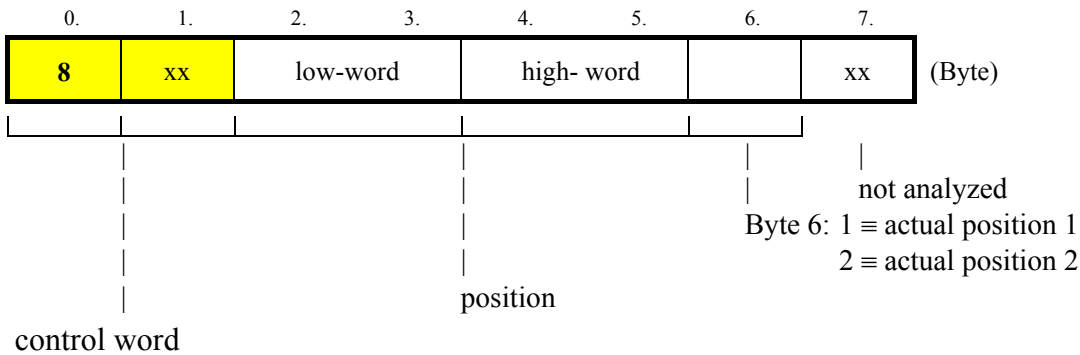

6.8 Control word „set BIAS processing pointer“(9)

With this telegram the processing pointer in a BIAS program can be Set to a new line.
 In order to be able to use this function the operating mode position control with BIAS processing must be set in the digital drive.
 During the processing of the BIAS program telegrams be still be sent to the digital drive.
 In this regard please observe that move commands via the CAN bus and commands of the BIAS processing have equal status and are processed in the respective task of the digital drive.

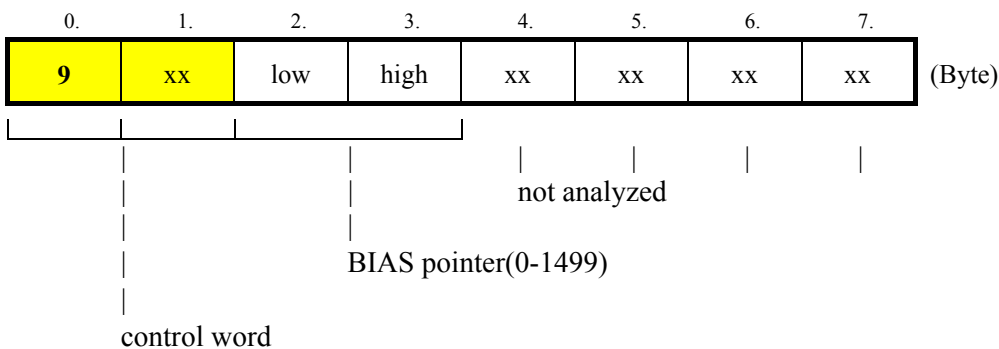



Vendor class 100: Receive control block

6.9 Control word „move +“(10) and „move -“(11)

In position control the axis moves infinitely in a positive or negative direction.

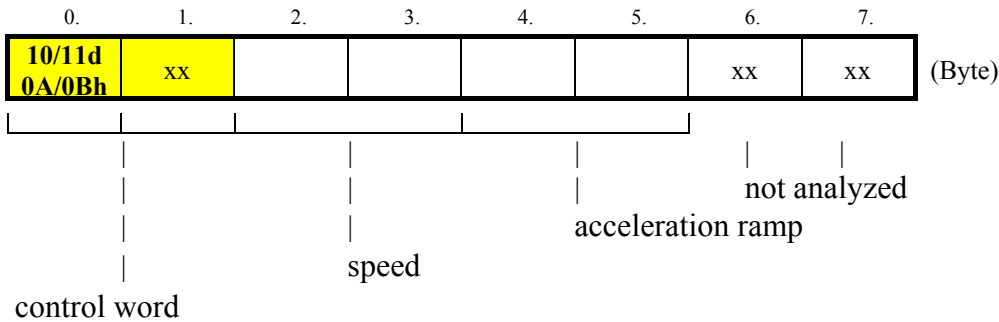

The move command can be finished with the command „stop 06“ or „stop with ramp 07“.

6.10 Control word „move synchronous“(12)

Starts the position synchronous positioning of the axis according to an external master encoder.

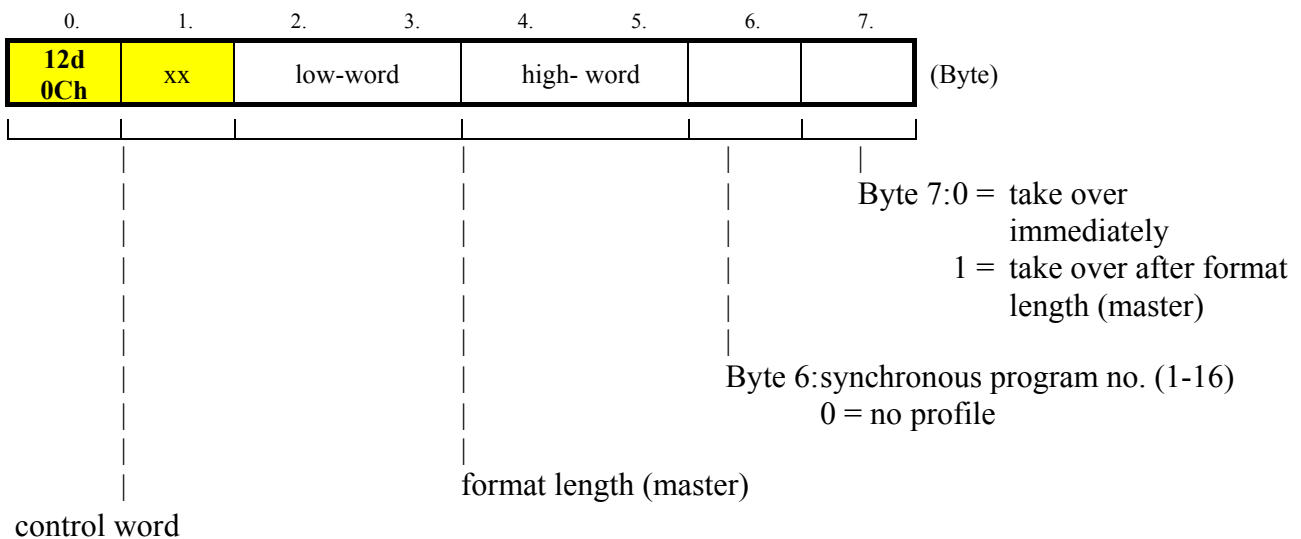



Vendor class 100: Receive control block

6.11 Control word „synchron setting“(13)

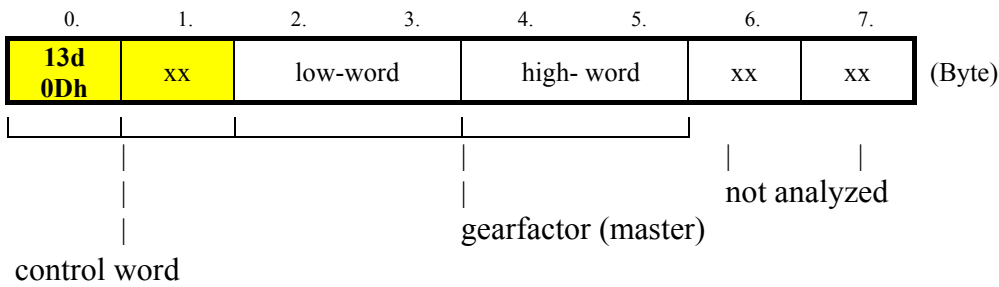

6.12 Control word „load ramp“(19)

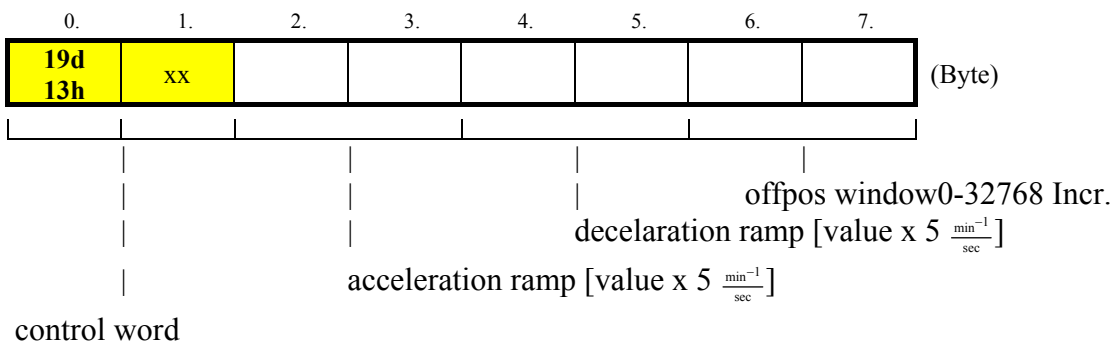

6.13 Control words 635/637/637+: „disable/enable“(20/21)

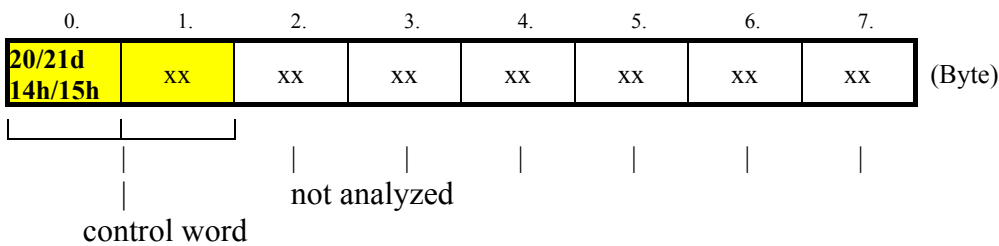



Vendor class 100: Receive control block

6.14 Control word 635/637/637+: „RESET“(22)

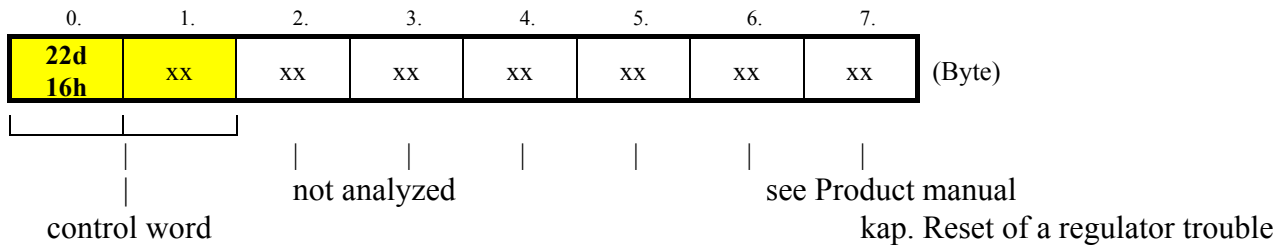

6.15 Control words 635/637/637+: „save data“(23)

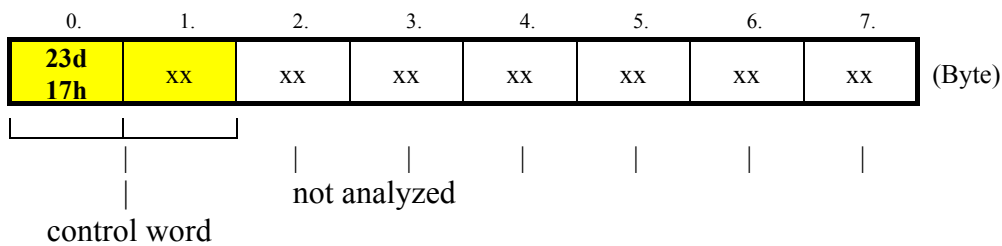



Vendor class 100: Receive control block

6.16 Control word „operating mode speed loop“(24)

By this telegram you can send new speed values to the digital drive.

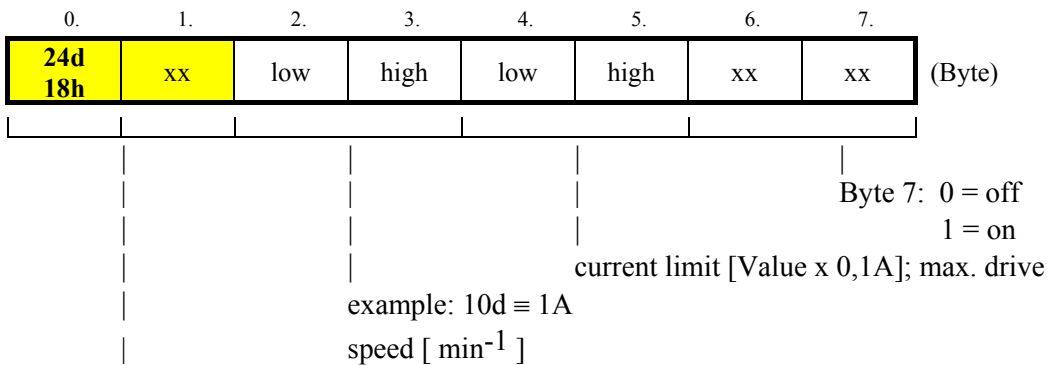

control word

A negative speed is created through the 2 complement.

Example:

$$\begin{aligned}
 + 2000 &\equiv 0x7D0 \\
 - 2000 &\equiv 0xF82F
 \end{aligned}$$

6.17 Control word „write variable / flags“(25)

By this telegram the values of the variables an the flags for BIAS programming can changed.

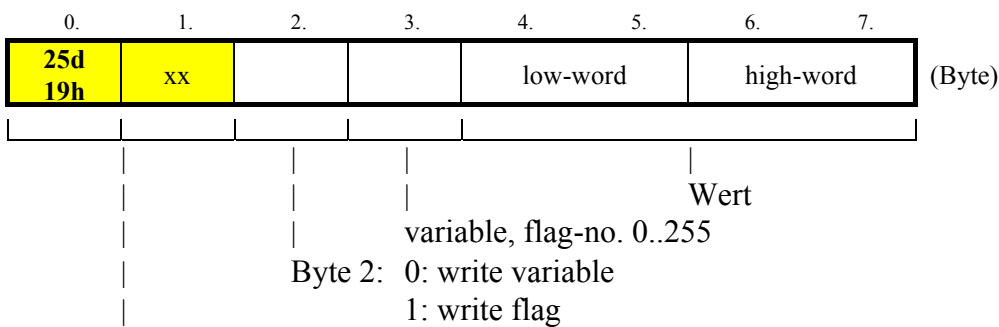

control word



7 Vendor class 100

7.1 Vendor class 100: Attr. 100 „read status”

DeviceNet DATA CHANNEL
 (Digital drive 635/637637+ → participant)

Get Attribut single: class 100 attribute 100			
Byte	data type	meaning	note
0	Byte	copy from control word byte 0 (0-25)	
1	Byte	copy from control word byte 1 (xx)	
2	low word	actual position of the controller + 2000 ≡ 0x00007D0 - 2000 ≡ 0xFFFFF82F	D0 2F
3			07 F8
4	high word		00 FF
5			00 FF
6	Bit 7	input X10.4	input status of the controller
	Bit 6	input X10.11	
	Bit 5	input X10.25	
	Bit 4	input X10.2	
	Bit 3	input X10.14	
	Bit 2	input X10.15	
	Bit 1	input X10.24	
	Bit 0	input X10.22	
7	Bit 7	target position reached (according to the travel commands 03,04,05)	output status of the controller
	Bit 6	bearing controller initial state (in position)	
	Bit 5	limit switch achieved	
	Bit 4	output X10.12	
	Bit 3	output X10.13 (negated logic)	
	Bit 2	output X10.20 (negated logic)	
	Bit 1	output X10.23	
	Bit 0	output X10.8	



7.2 Vendor class 100: Attr. 101 „ext. read status”

Get Attribut single: class 100 attribut 101

Byte	Datotyp	Meaning (Bit=1)	Note	
0	Bit 7	position reached	status word 1 low Byte	0xC3
	Bit 6	internal used		
	Bit 5	internal used		
	Bit 4	controller disabled (COM 2)		
	Bit 3	target position reached		
	Bit 2	internal used		
	Bit 1	COM 2 host login		
	Bit 0	COM 2 active (RS232/422)		
1	Bit 7	trailing distance ok (dyn)	high Byte	0x88
	Bit 6	trailing false (storing)		
	Bit 5	reported		
	Bit 4	controller disabled (COM 1)		
	Bit 3	position reached (dynamically)		
	Bit 2	internal used		
	Bit 1	COM 1 Host login		
	Bit 0	COM 1 active		
2	Bit 7	Setpoint in setpoint zero window	status word 0 low Byte	0x00
	Bit 6	Warning output stage temperature		
	Bit 5	Warning I ² t-regulator		
	Bit 4	Warning motor temperature		
	Bit 3	Warning I ² t-motor		
	Bit 2	Ballast active		
	Bit 1	Undervoltage		
	Bit 0	Output stage passive		
3	Bit 7	Limit switch reached	high Byte	0x30
	Bit 6	Warning		
	Bit 5	Speed regulator without I-gain		
	Bit 4	internal used		
	Bit 3	EEPROM storage runs		
	Bit 2	Warning ballast power		
	Bit 1	N/I switchover		
	Bit 0	internal used		
4	Bit 7	I ² t-motor	Error status word low Byte	0x00
	Bit 6	Over-voltage		
	Bit 5	Temperature of the output stage too high		
	Bit 4	motor temperature too high		
	Bit 3	resolver error		
	Bit 2	internal used		
	Bit 1	release X10.22 before ready		
	Bit 0	Over current (software-interruption)		
5	Bit 7	Watchdog-reset	high Byte	0x00
	Bit 6	Internal stop		
	Bit 5	Over current (hardware-interruption)		
	Bit 4	internal used		
	Bit 3	internal used		
	Bit 2	EEPROM check total not ok		
	Bit 1	Ballast power exceeded		
	Bit 0	I ² t-regulator		
6	Low Byte	actual speed		0x0000
7	High Byte			

Example for an answer telegramm



8 Vendor class 101: Attr. 0-255 „read variable“

DeviceNet DATA CHANNEL
(Digital drive 635/637637+ → participant)

Get Attribut single: class 101 attribute 0 - 255

By this telegram is is possible to read the 256 values of the variables of the drive.

attribut 0 = variable 0
attribut 255 = variable 255

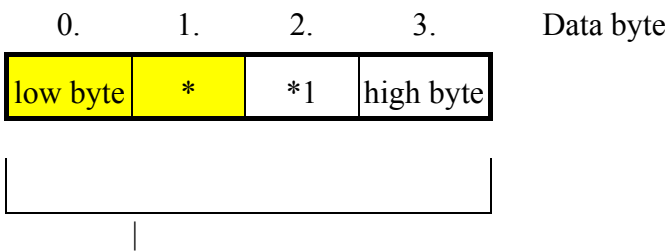

value of variable

9 Reserved

10 Example for operating the 635/637/637+ via the DeviceNet bus system

10.1 Positioning via DeviceNet

1. Step:

Host **login** via the DeviceNet bus

(necessary once after power-on, or always after host logout, respectively)

☞ send control telegram with 01h, Host **login** in the control word byte 0 to the 635/637/637+.

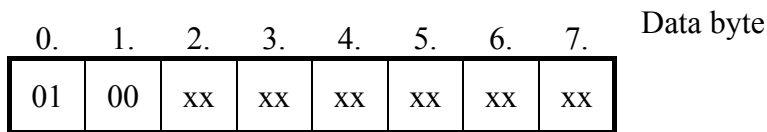

2. Step:

check host **login**

After host **login** in the response telegram in the data byte 2 the bit 1 , COM2 host **login** will be set.





Example for operating the 635/637/637+ via the DeviceNet bus system

Positioning via DeviceNet

3. Step:

positioning with ‚start absolute‘

If, in this connection, the acceleration and deceleration ramps stored in the 635/637/637+ are not to be taken over, a telegram (control word 19) with the desired ramps must first be sent to the 635/637/637+.

load ramps

☞ Send control telegram with the control word ‚load ramps‘ and the desired parameters for acceleration and deceleration.

for example:

- acceleration 1000 (\equiv 3E8) [value x 5 $\frac{\text{min}^{-1}}{\text{sec}}$]
- deceleration 1500 (\equiv 5DC) [value x 5 $\frac{\text{min}^{-1}}{\text{sec}}$]
- offpos window 100 (\equiv 64h)

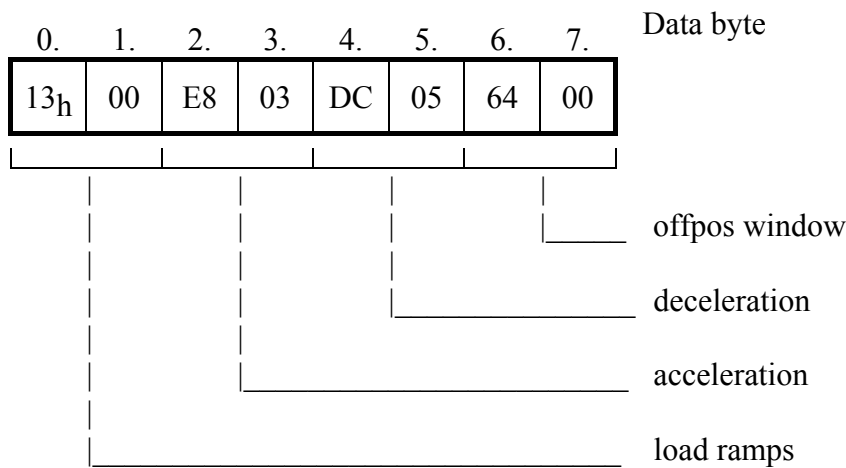



Example for operating the 635/637637+ via the DeviceNet bus system

Positioning via DeviceNet

- ☞ send control telegram with the control word ‚start absolute‘ and the parameters for position and speed.

1. Example:

- Position 500,000 increments (500,000d \equiv 0007A120h)
- speed 2000 (\equiv 7D0h) [rpm]

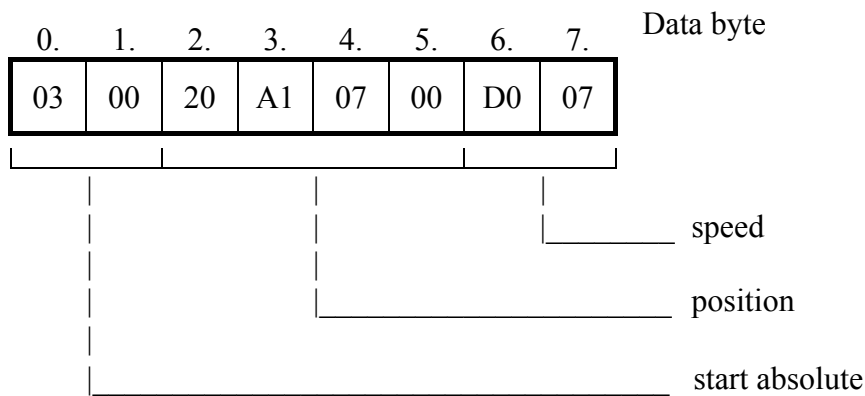

2. Example:

- Position 0 increments (00d \equiv 00h)
- speed 2000 (\equiv 7D0h) [1/rpm]

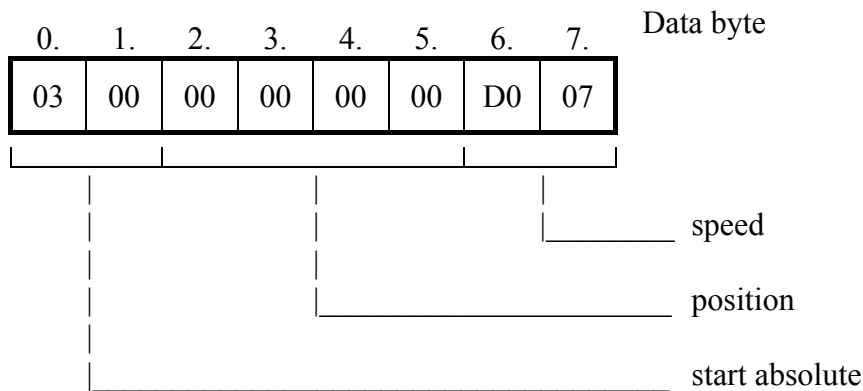



Example for operating the 635/637637+ via the DeviceNet bus system

Positioning via DeviceNet

4. Step:

check ‚position reached‘

Request bit 7 ‚position reached‘ in data byte 6 in the response telegram and /or compare the position value (bytes 0 - 3) with the setpoint value.

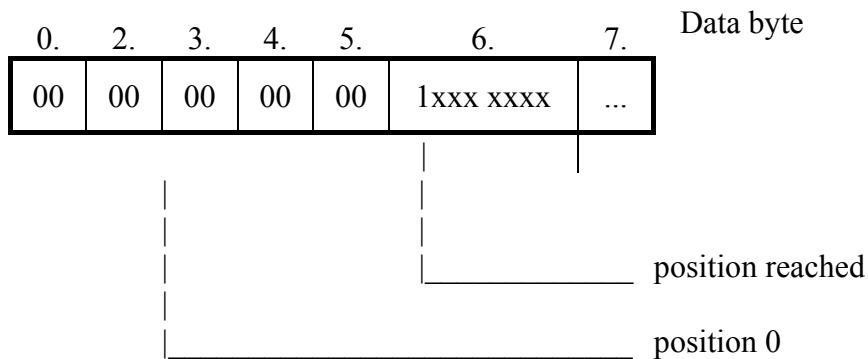

5. Step:

host log**out** via the DeviceNet bus

☞ send control telegram to the 35/637/637+
with 02h ‚host log**out**‘ in the control

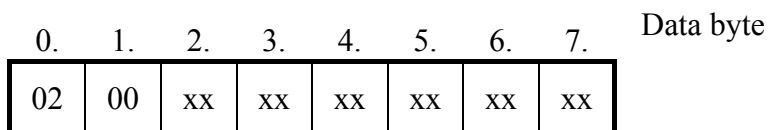



Example for operating the 635/637/637+ via the DeviceNet bus system

10.2 BIAS programm-selection via DeviceNet

1. Step:

Host login via the DeviceNet bus

(necessary once after power on, or every time after host logout)

- ☞ send control telegram with 01h ‚Host login‘ in the control word byte 0 to the 635/637/637+.

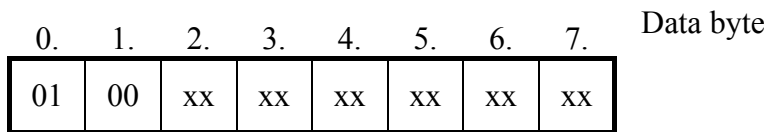

2. Step:

check host login

- ☞ request status (with a remote frame)

In the response telegram, bit 1 ‚COM2 host login‘ in data byte 2 is set after the host login.

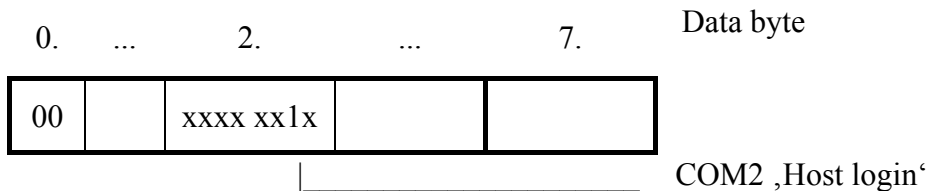



Example for operating the 635/637/637+ via the DeviceNet bus system

BIAS programm-selection via DeviceNet

3. Step:

program-selection with control word (9)
,set BIAS-processing pointer‘

Example:

- start program at processing pointer 100 (100d \equiv 0064h)

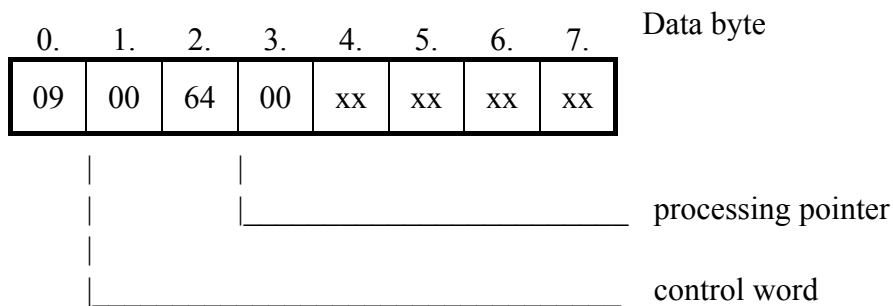

4. Step:

host **logout** via the DeviceNet bus

☞ send control telegram to the 635/637/637+
with 02h ,host **logout**‘ in the control word byte 0.

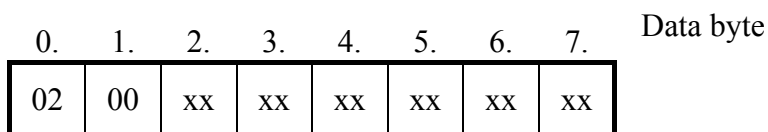

11 Eurotherm servo controllers communicate with the Allen-Bradley plc

This chapter describes the connection between the Eurotherm servo controllers and the Allen-Bradley plc.

In this chapter it isn't a goal, to describe the connection in details. It's only an introduction. For more information see the documentation for the plc and the DeviceNet scanner from Allen-Bradley

11.1 Network Configuration with RSNetWorx

For communication by DeviceNet, the scanner must be configured before. This will be done with the configuration software RSNetWorx.

After starting RSNetWorx start with a new Project.

Select the wished slaves from the hardware catalogue and insert in the project.

If all slaves already connected to the DeviceNet, the scanner can scan the configuration via the bus.

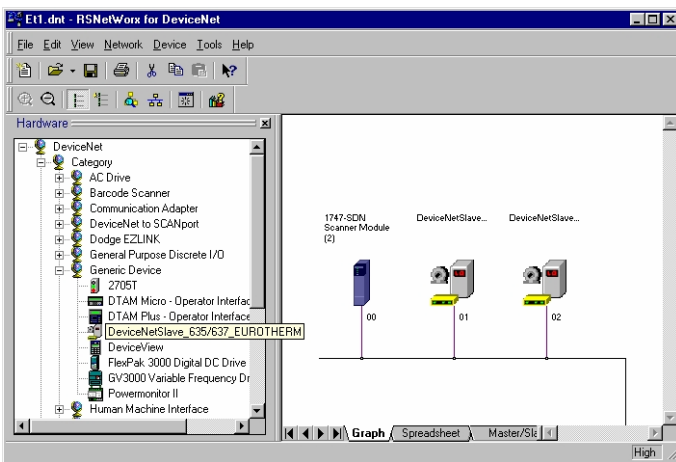

When you have entered all devices to the project, you could add the devices to the scanlist. (see righthand side)

When **Automap on Add** is active RSNetWorx will automatically map the in and output address ranges of this devices.

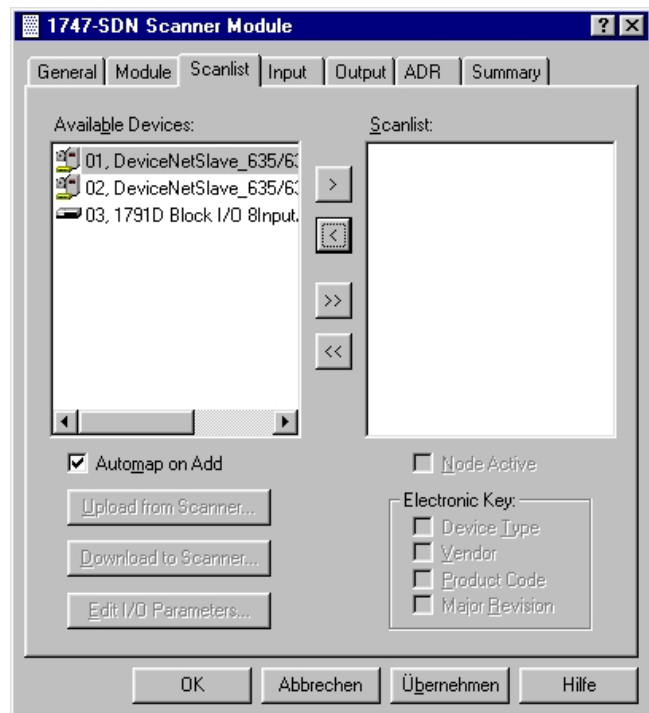

CAN-Dnet2.jpg



Eurotherm servo controllers communicate with the Allen-Bradley plc Network Configuration with RSNetWorx

The picture below shows an example when the devices are added to the scanlist

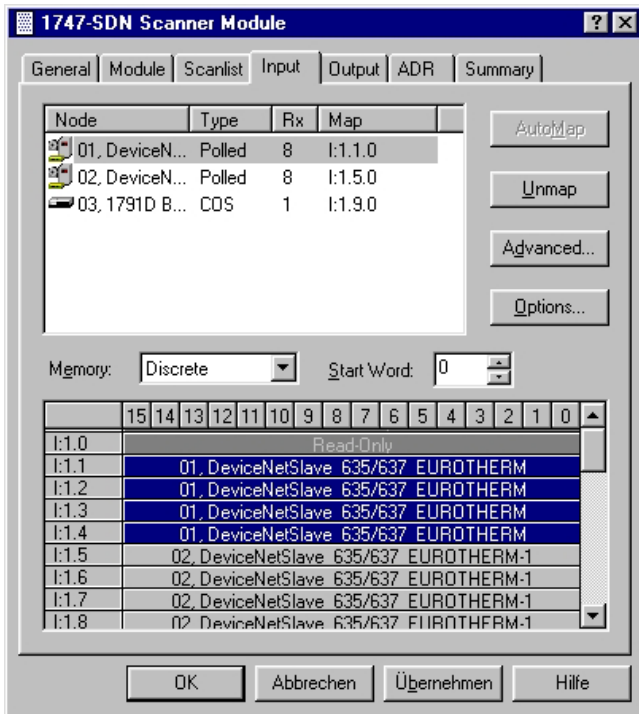

CAN-Dnet3.jpg

At least download the configuration to the scanner.

11.2 PLC programing with RSLogix 500 (Allen-Bradley)

To control the DeviceNet slaves via the plc, the scanner has five data areas to transfer data, status and command information.

The DeviceNet Scanner has:

- 4 data areas for transfer data between the scanner an the plc
- 1 data area for status and command information.

The 4 data areas for transfer data are:

- SLC input / output image table
- SLC M0 / M1file

words	SLC-input data	words	SLC-output image
0	status	0	command
1-31	DeviceNet-input data	1-31	DeviceNet-output data

words	SLC-M1-File	words	SLC-M0-File
0-149	DeviceNet-input data	0-149	DeviceNet-input data
150-223	see scanner manual	150-223	see scanner manual
224-255	explicit message control	224-255	explicit message control

Details you will found in the Allen-Bradley Installation Instructions 1747-5.8.pdf to the DeviceNet Scanner 1747 SDN.

Eurotherm servo controllers communicate with the Allen-Bradley plc

11.2.1 Transmitting data between the processor files and the M0- / M1-files

The processor does not contain an image of the M0 and M1 files. For access to DeviceNet data first you must copy this data from M0 and M1 files to processor data files or vice versa using the COP (Copy) instruction.

The following example copied the **input data** in two 128 word blocks from M1 file to the N file 174.

The **output data** are copied in two 128 word blocks from N file 175 to the M0 file.

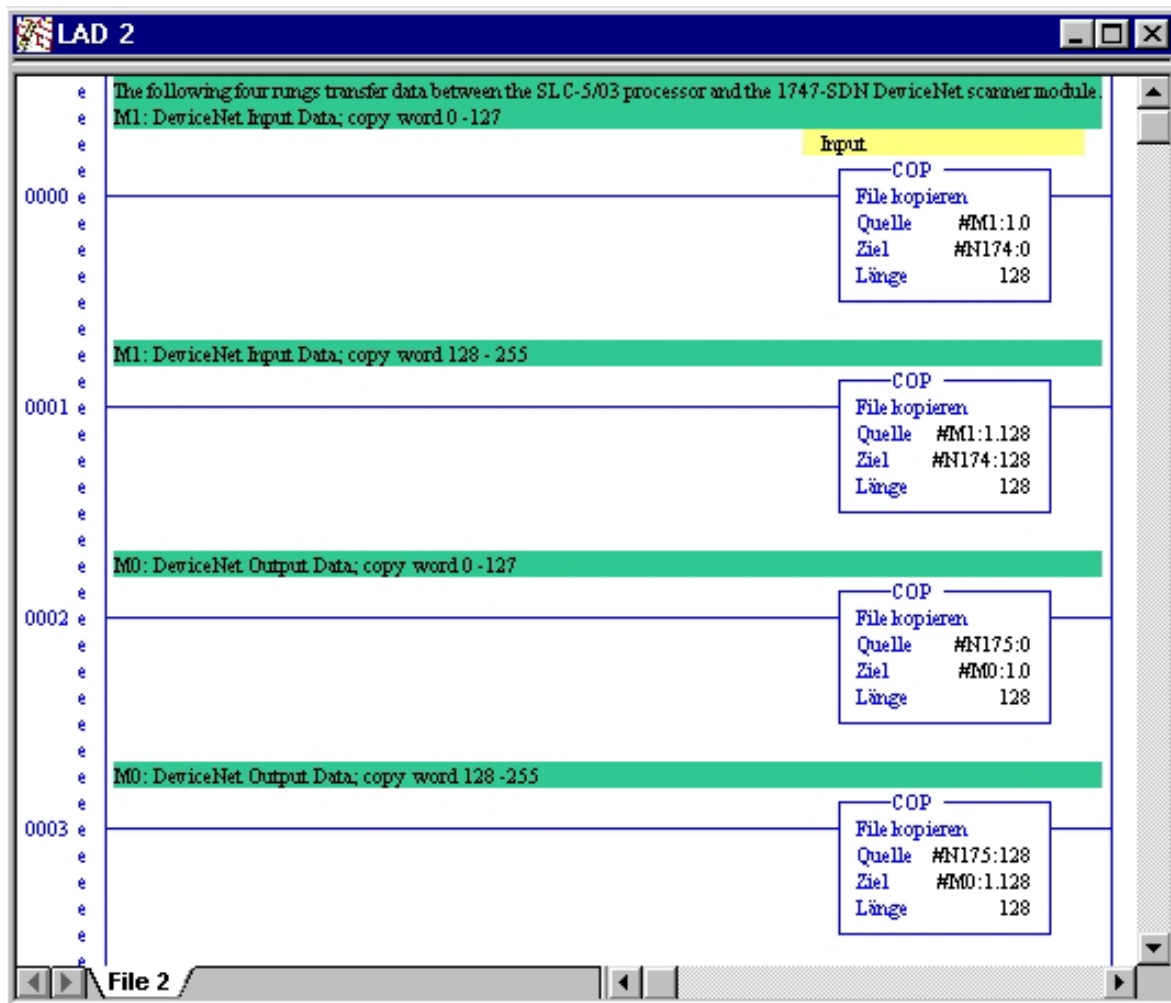



Eurotherm servo controllers communicate with the Allen-Bradley plc

11.2.2 Programming control for Explicit Messaging Service

In addition to the cycle data exchange by DeviceNet an **Explicit Messaging Service** is defined. With this possibility you can send commands to the slaves while the cycle data exchange. The Eurotherm Servo controller use this functionality to read out the special data class 100, Attribute 101 with the **Get_Attribute_Single**.

More details you will found in the Allen-Bradley Installation Instructions 1747-5.8.pdf to the DeviceNet Scanner 1747 SDN.

Before attempting Explicit Messaging the scanner should be updated to V3.01 firmware.











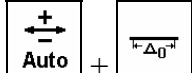

For Explicit Messaging the M0-/ M1 files use the data area 224 to 255. Up to **ten** 32-word **transaction blocks** may be queued within the scanner for Explicit Messaging. A transaction ID is used to differ the separate services.

Sequence:

1. For request a Explicit Message copy the formatted data to the M0 file. Start with word 224.
2. When the response has been received by the scanner the bit 15 of the scanner status register goes to 1.
3. Test the transaction ID to make sure it matches the request value.
Then copy the input data from M1 file into a file in the SCL-500.
4. At least clear the request by enter the transaction ID and the command 4 “delete transaction” in the M0 file at word 224. After this is executed, bit 15 of the scanner Status Register should go to 0.

12 Reserved

13 Standard reference (Homing) modes overview

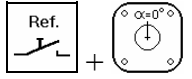
								
								
	0	1	0 (6)	1 (7)	12	13	18	19
	2	3	8	9	14	15	20	21
	4	5	10	11	16	17	22	23

The reference numbers 0...23 listed here, must be entered into the **Object: homing method** (Index 6098h) with the values -24...-1 !!!



= resolver zero position



= reference sensor



= positive direction



= negative direction



= automatic directional selection



= reference point shifting

13.1 Search for reference and modes

The search for reference of the axis is always necessary, when there must be a fixed relationship between the electrical and the mechanical zero point of the axis, e.g. with a rotary axis with a tool or a linear axis. In order to be able to solve this task flexibly, 24 standard reference modes are offered. These are explained in the following text.

Standard reference (Homing) modes

13.2 Search for reference to the resolver zero position



The resolver located in the motor represents an absolute position registering system. The zero position of this system can be used to create a zero point with high repeat accuracy. Figure 1 shows a typical application. The axis to be referenced is connected directly with the motor, so that a clear coordination between the motor and output position results.

Process: The axis executes a counter preset according to the resolver zero position and moves to the zero point in the specified direction.

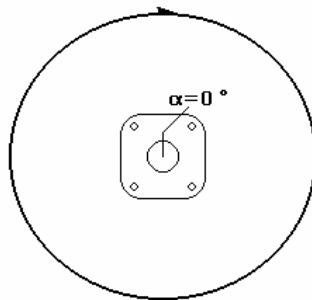

Figure 1: Search for reference to the resolver zero position

13.3 Search for reference to the reference sensor



Searches for reference to an external reference sensor are necessary wherever no exact assignment at the motor to output position can be made. Typical application examples are systems with gearboxes as shown in figure 2.

Process: The axis starts the search for reference in the specified direction. The actual position is zeroed upon detection of the Low-High edge of the external reference sensor. At the same time the axis is stopped via the active deceleration ramp.

Note:

1. If input X10.8,9,10 not configured¹ as "reference sensor", a start fault occurs upon execution of a search for reference with sensor.
2. If the zero position is not reachable in the specified direction² after stopping the axis, the zero point is not moved to.

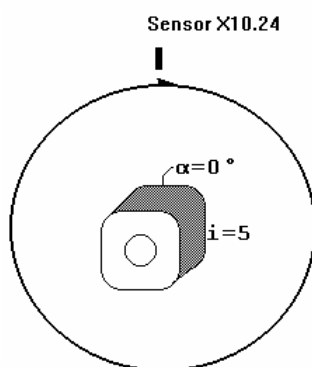
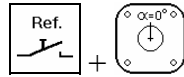

Figure 2: Search for reference to an external reference sensor

¹ "Configuration", in-, outputs, "function 1 - reference sensor"

² In combination with the automatic directional selection this limitation does not apply

13.4 Search for reference to the reference sensor and the resolver zero position



The reference modes with reference sensor and resolver zero position represent a combination of the individual modes. They are always required wherever no clear coordination of motor position to output position can be made on the one hand, on the other hand however, the high repeat accuracy of the resolver zero point is required.

Typical applications are also on the other hand systems with gearboxes³ (see figure 2).

Process: The axis starts the search for reference in the specified directions. At sensing of the Low-High edge of the external reference sensor, a counter preset is executed according to the following resolver zero position. At the same time the axis is stopped via the active deceleration ramp. If the zero point can be reached in the specified direction, this is subsequently moved to.

Note:

1. If input X10.8,9,10 is not configured as "reference sensor", a start fault will occur upon execution of a search for reference with sensor.
2. If the zero position is not reachable in the specified direction after stopping the axis, the zero point will not be moved to.

13.5 Search for reference with automatic directional selection



The previous reference types can be combined with the automatic directional selection. If the automatic directional selection is active, there are 2 differences.

1. The axis can use both reference directions. As a result, the zero point can always be moved to.
2. At reference modes with reference sensor, the search for reference is started in the opposite direction, if the reference sensor is already active at the start of the search for reference (see figure 3).
 After the reference sensor becomes free (inactive) the axis is stopped (see figure 4).
 Subsequently the reference sensor is moved to in the specified reference direction and the search for reference is ended according to the reference mode.

Search for reference with automatic directional selection

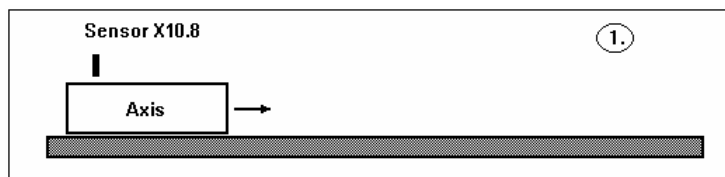

Figure 3

Start of the search for reference with automatic directional selection

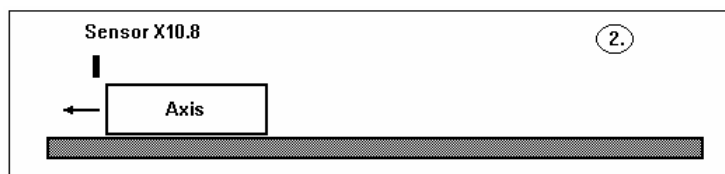

Figure 4

³ With rotary axes the gearbox ratio must, however, allow a clear position assignment

13.6 Search for reference with reference point shifting



The previous reference modes can also be combined with the reference point shifting. With this, the actual position 0 is shifted by the amount specified in the "path" parameter from the zero point found according to the reference mode (see figure 5).

Note:

1. If the actual position 0 is not reachable in the specified direction after stopping the axis, the actual position 0 is not moved to.

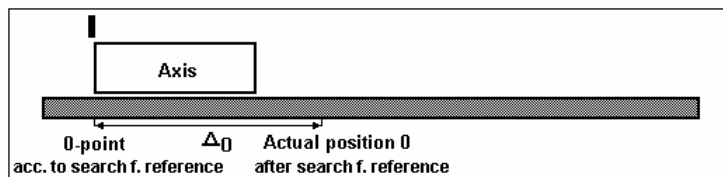

Figure 5: Reference point shifting



14 Index

A	
acceleration ramp.....	21
B	
baudrate	9
BIAS pointer.....	19
BIAS processing pointer.....	19
BIAS programm-selection	30
bus cable.....	8
Bus termination.....	9
C	
cable length.....	8
Cables and accessoires	10
Communication	8
Configuration.....	12
control word.....	16
D	
datatransfer	11
deceleration ramp	18, 21
Definitions of the data fields	13, 14
disable (Servo-)	21
E	
enable (Servo-)	21
Example	26, 27, 28, 29, 30, 31
F	
flags	23
H	
Host login / logout.....	17
I	
interface	10
L	
layout	7
load ramp.....	21
N	
nodeaddress, MAC ID.....	8
Numbers representation.....	14



Index

P

Pin assignment COM2.....	10
position (negative).....	17
Positioning via DeviceNet.....	26
preset counter.....	19

R

reference modes.....	39, 40, 41, 42, 43
reference run.....	18
RESET.....	22

S

save data.....	22
scaling.....	14
Short list of instructions.....	12
speed loop.....	23

V

variable.....	23
---------------	----



15 Modification Record

Version	Modification	Chapter	Date	Name	Comment
V01.17SA2000	1. Version		18.04.2000	T. Saladin	
V01.18SA2000	2. Version	2.5 , 6	26.04.2000	T. Saladin	
V01.20SA2000	3. Version	7	18.05.2000	H. Mund	
V02.31SA2000	4. Version	11	04.08.2000	H. Mund	
V03.36SA2000	5. Version	all	01.09.2000	Iris Worm	Eurotherm-Format
V04.44SA2000	Corrections	-	03.11.2000	N.Dreilich	
V0502	DeviceNet datatransfer User manual for the Digital drive Vendor class: 101; Attr.0-255 separation German / English	3 1 8 all	08.10.2002	T. Saladin N.Dreilich	expand supplement new